

Degaussing

finished and semi-finished
industrial products

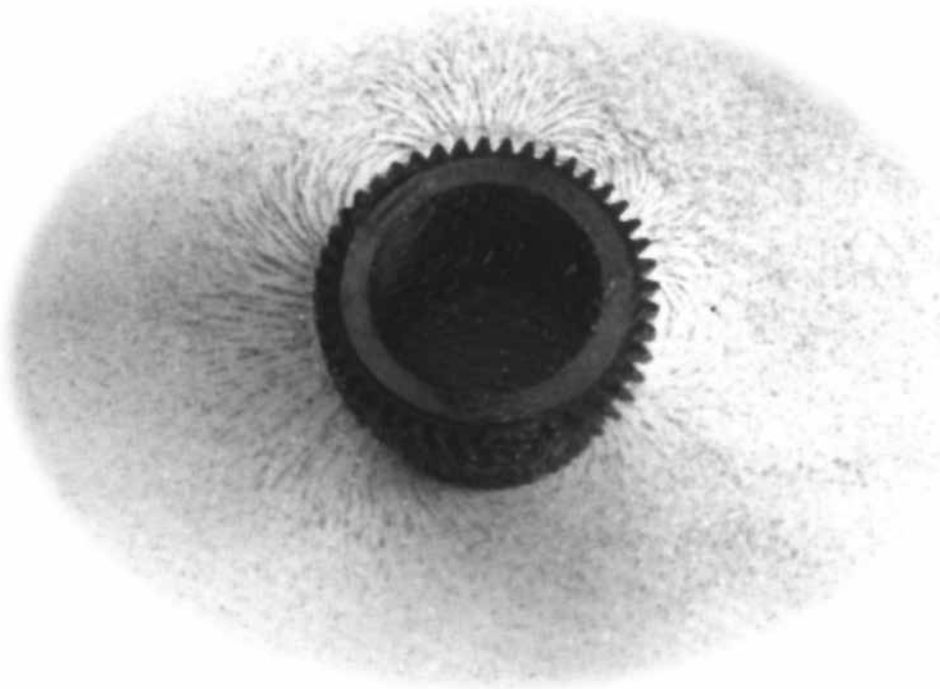
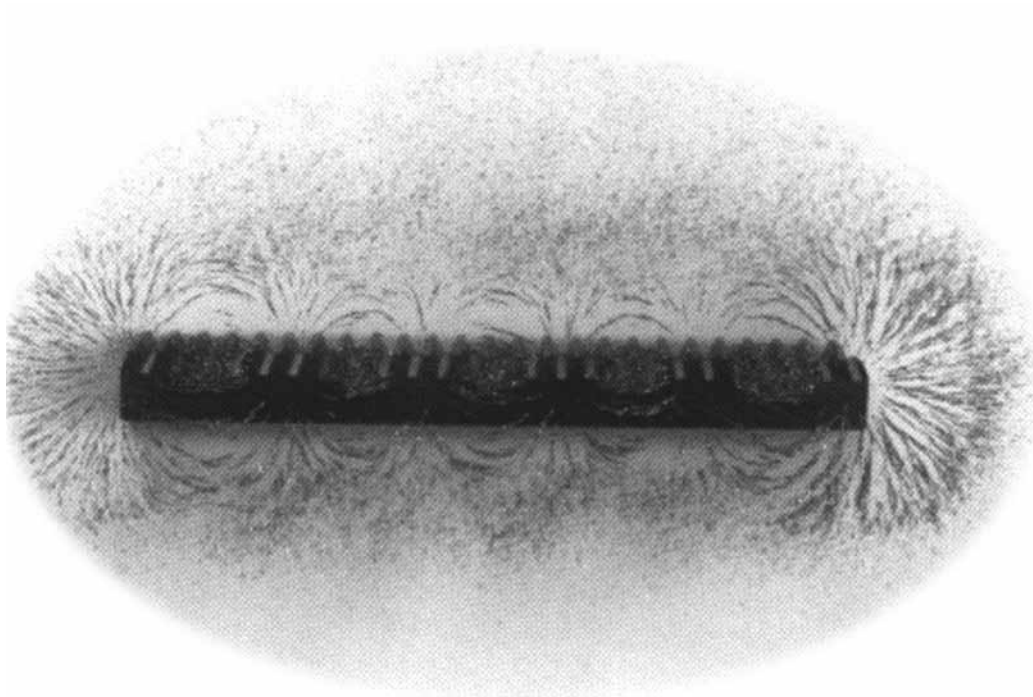

Chapter	Topic	Page
1.	Introduction - Definitions	4
2.	Causes of magnetizing and effects	4
3.	Degaussing - Function principle	4
3.1	Overview	4
3.2	Degaussing coils - function principle	4
3.3	Degaussing yokes - function principle	5
3.4	Rotation coil - function principle	5
4.	Parameters influencing residual magnetism	5
4.1	Preferred directions for degaussing	5
4.1.1	Preferred direction for transport of the workpieces through a tunnel coil	5
4.1.2	Preferred direction for transport of the workpieces over a degaussing yoke	6
4.2	Bulk factor	6
4.2.1	Bulk factor of degaussing coil	6
4.2.2	Bulk factor of degaussing twin yoke	6
4.3	Frequency of degaussing field	6
4.4	Magnetic field intensity	7
4.5	Passage speed	7
4.6	Shielding effects	7
4.6.1	Shielding by transport containers	7
4.6.2	Shielding by bulk material	7
5.	Measuring of magnetic field intensity with Vallon field strength meter VFM1	7
6.	Data for project planning of a degaussing installation	7
7.	Product range and contact	7
8.	Conversion table for magnetic field strength and induction	8
9.	Experience of customers working with Vallon degaussing installations	8
10.	Degaussing coils in modular design	9
11.	Degaussing yokes	9
12.	Examples of complete degaussing installations	10

1. Introduction

This brochure gives you an overview on degaussing for industrial applications.

Our goal is not scientific completeness but to provide the user with a useful manual which covers the topic exhaustively and in a comprehensible manner.

Definitions:

Magnetic field:

The condition inside and around a magnet is called a magnetic field. The magnetic field can be compared with the gravity field of the earth. The magnetic field has a determined orientation and a value.

Field line:

Line to visualize the intensity of a magnetic field. The intensity of a field is expressed by the number of field lines (density of field lines).

A/cm:

Unit indicating the intensity of a magnetic field (magnetic field strength).

Residual magnetism:

Magnetic field after degaussing.

Coercivity:

Magnetic field strength which is necessary to neutralize the residual magnetism of a material (magnetic intensity = zero).

Wei domain:

Inside a ferromagnetic crystal, a larger amount of atoms always has the same orientation. This area can be considered from the outside as a domain (Wei domain) (0.001 to 0.1 mm³ volume).

Eddy currents:

Cyclic currents in conductive materials can occur as a result of alternating magnetic fields.

2. Causes and effects of magnetization

The reasons for magnetization of workpieces are various. Fairly often, they cannot easily be ascertained in practice. The main cause are artificial magnetic fields acting in direct vicinity of the workpieces. These magnetic fields can be of intended or unintended origin, as for example: magnetic transport, induction hardening, magnet gripper, magnet chuck devices and others. Mechanical vibrations and cold forming under the influence of those magnetic fields reinforce or enhance the process of magnetization. The effects can be the following:

- ☒ Metal scobs and wheel swarf stick to the workpiece
- ☒ Sintered tools wear off faster
- ☒ Down times for robots / automatic feeding systems due to parts sticking together.
- ☒ Magnetic field sensors are falsely activated
- ☒ Measurement errors at highly sensitive measuring instruments.
- ☒ Faulty welding seams
- ☒ Electron beam welding becomes impossible
- ☒ Irregular thickness of layers at hard chromium plating
- ☒ Tritanium nitride coatings: irregular repartition of the gaseous coating material.
- ☒ Edges breaking off at EDWC (electric discharge wire cutting)

The below table shows the empirical values which are normally found.

Field strength (A/cm)	Effects
>200	permanent magnet
2-60	after magnetic holding plate workpieces stick together
>10	metal scobs adhering
>8	minimum metal parts adhering
>4	wheel swarf adhering
>2	electron beam welding is affected
0,4	field strength of earth gravity

3. Degaussing principle

In practice, mainly the following methods are used:

Strong alternating magnetic fields, leading the workpiece out of the field at constant speed. Vallon uses only this method since it provides the best degaussing results.

Decreasing alternating magnetic field, the workpiece is not moved (for example holding plates of grinding machines).

Strong permanent magnets are quickly rotated in relation to the workpiece, and moved along with it (degaussing gyro).

Heating to >800°C (exceeding Curie-point), i. e. structural transformation (which often entails material deterioration).

3.1 Degaussing coils

The coil is fed with alternating current and creates an alternating magnetic field (see fig.1).

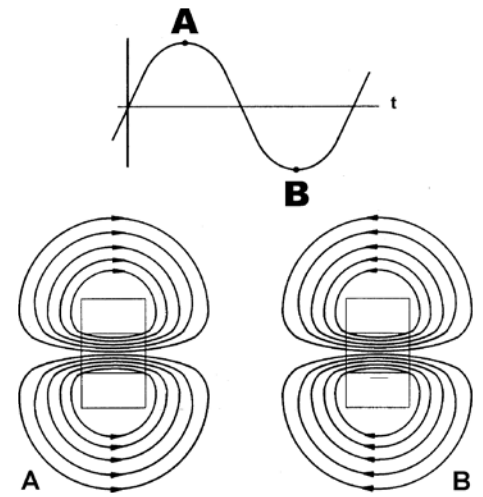

Fig. 1 A-Alternating field - coil empty B

The density of magnetic field lines is at its maximum in the coil centre, and is strongly decreasing towards the outside.

If a ferromagnetic workpiece (steel) is introduced into the coil, it will be flooded by an alternating magnetic field (see fig. 2)

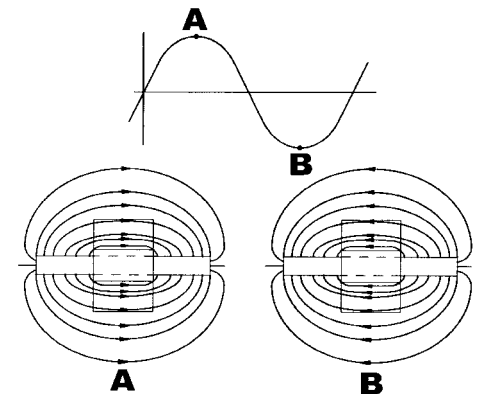

Fig. 2: Alternating field inside workpiece

The conductivity of steel is upto 2000 times higher than that of air. Therefore, all field lines are gathering inside the coil in the workpiece.

Degaussing is done during a continuous movement of the workpiece, leading out of the coil. Inside the coil opening, the polarity of the divers Wei domains is continuously being reversed, according to the magnetic field induced from the outside.

Outside the coil, the magnetic field is so weak - at a certain distance - that the polarity of the Wei domain is no longer reversed; the Wei domain remains in its current position. Fig 3 shows the demagnetized part on the left, and on the right, the Wei domains which are still in the process of changing poles.

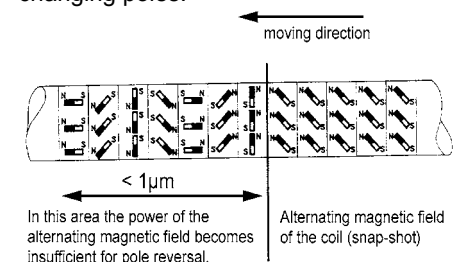

Fig. 3: Degaussing effect

The advantage of degaussing according to this method is that extremely low residual magnetic fields are achieved.

3.2 Degaussing yokes

For some applications, degaussing yokes are better suited than degaussing coils. The reasons are the following:

1. At its surface, the degaussing yoke creates a field of extremely high magnetic intensity.
 2. The field lines emerge vertically from the active surface of the degaussing yoke (fig.4).
 3. The gradient of the field lines is restricted to the space above the active surface, i. e. computers, screens and other devices susceptible to magnetism placed in the direct vicinity will not be affected.
- For degaussing of flat, single steel parts it is sufficient to carry out degaussing in one direction, preferable from below.

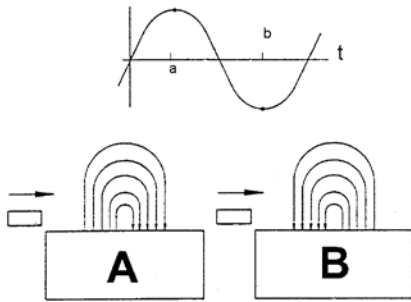

Fig. 4: Degaussing yoke

For large-height workpieces (typically > 60 mm), palletized in a container as well as for extremely hard steels, degaussing is performed from above as well as from below, i. e. a degaussing twin yoke creates a high density of field lines which penetrate the workpiece throughout.

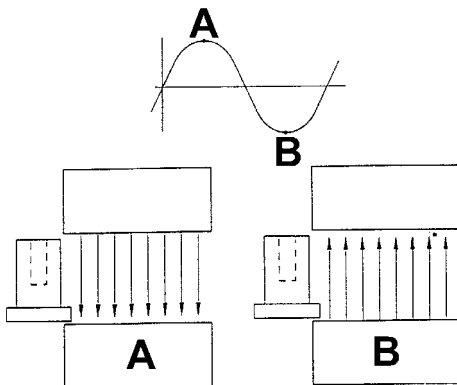

Fig. 5: Degaussing twin yoke

3.3 Functional principle - Rotation coil

Degaussing of round-shaped workpieces, i. e. races of ball bearings, piston rings, tubular springs, annular gear, pinion cages or solid cylindrical cutters, is done with a demagnetizing field which creates a high magnetic penetration inside its cyclic walling. In order to avoid mechanic rotation of the workpieces, the rotation coil creates a continuously self-rotating magnetic field which penetrates all sides of the vertically placed round workpieces. The low-frequency generator EG 2422 creates the required degaussing currents and current orientations.

The inside width of the rotation coil depends on the workpiece and should possibly be adapted to its diameter. The more thick-walled the workpiece is, the tighter the rotation coil has to be adapted to its surface. Standard sizes are as follows:

- EM 06R inside width 60 x 60 mm
- EM 10R inside width 100 x 100 mm
- EM 14R inside width 140 x 140 mm
- EM 16R inside width 160 x 160 mm
- EM 26R inside width 260 x 260 mm
- EM 36R inside width 360 x 360 mm

In addition to the rotation field, the low-frequency generator EG2422 creates various degaussing frequencies, so that a low frequency as for example 1 Hz of 2 Hz can be selected for extremely thick-walled objects.

In order to allow the workpieces to be guided centrally through the rotation coil, we recommend the use of a centering device, similar to fig. 6 and 7 (Vallon-Patent DE 36 25 621 and DE 37 38 401). Transport speed through the rotation coil is, as for standard coils, depending on working frequency.

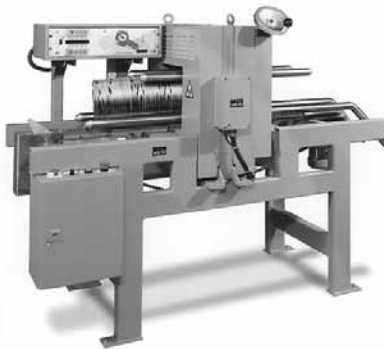

Fig. 6: Degaussing line with rotation yoke

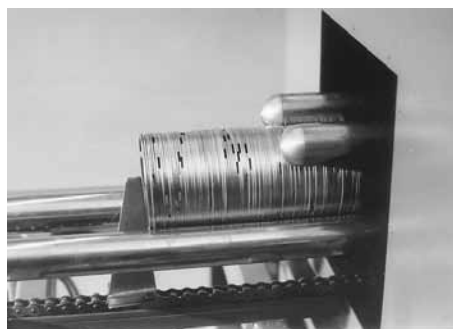

Fig. 7: Centering device

4. Parameters influencing residual magnetism

In order to achieve low residual magnetism, the following parameters need to be optimized:

1. preferred direction
2. bulk factor
3. frequency of degaussing field
4. magnetic field intensity
5. passage speed
6. shielding effects

Please find below a summary of the criteria for the process parameter:

4.1 Preferred direction

Depending on the geometrical shape of a workpiece, the best position is a position allowing the magnetic field lines to remain as long as possible inside the workpiece. For more complicated geometrical structures, it is necessary to repeat the passage through the coil in various directions, or to use rotating magnetic fields. Below, please find some examples; the best preferred direction is shown.

4.1.1 Preferred workpiece direction through a tunnel coil

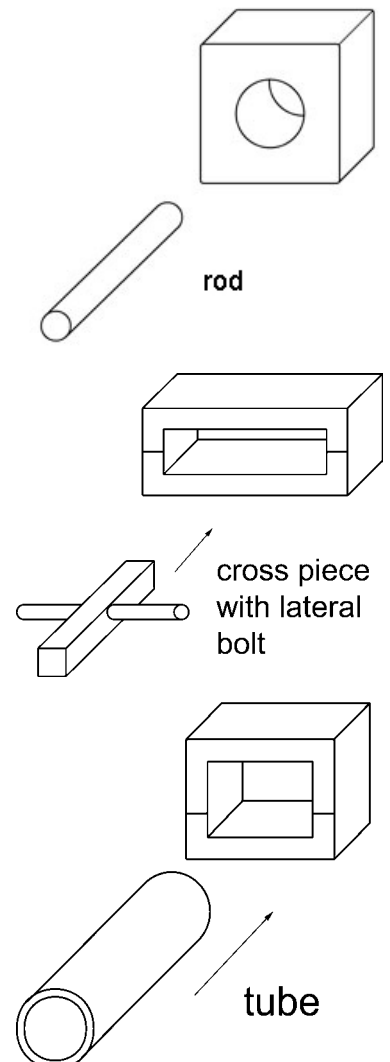

4.1.2 Preferred workpiece direction using a degaussing yoke

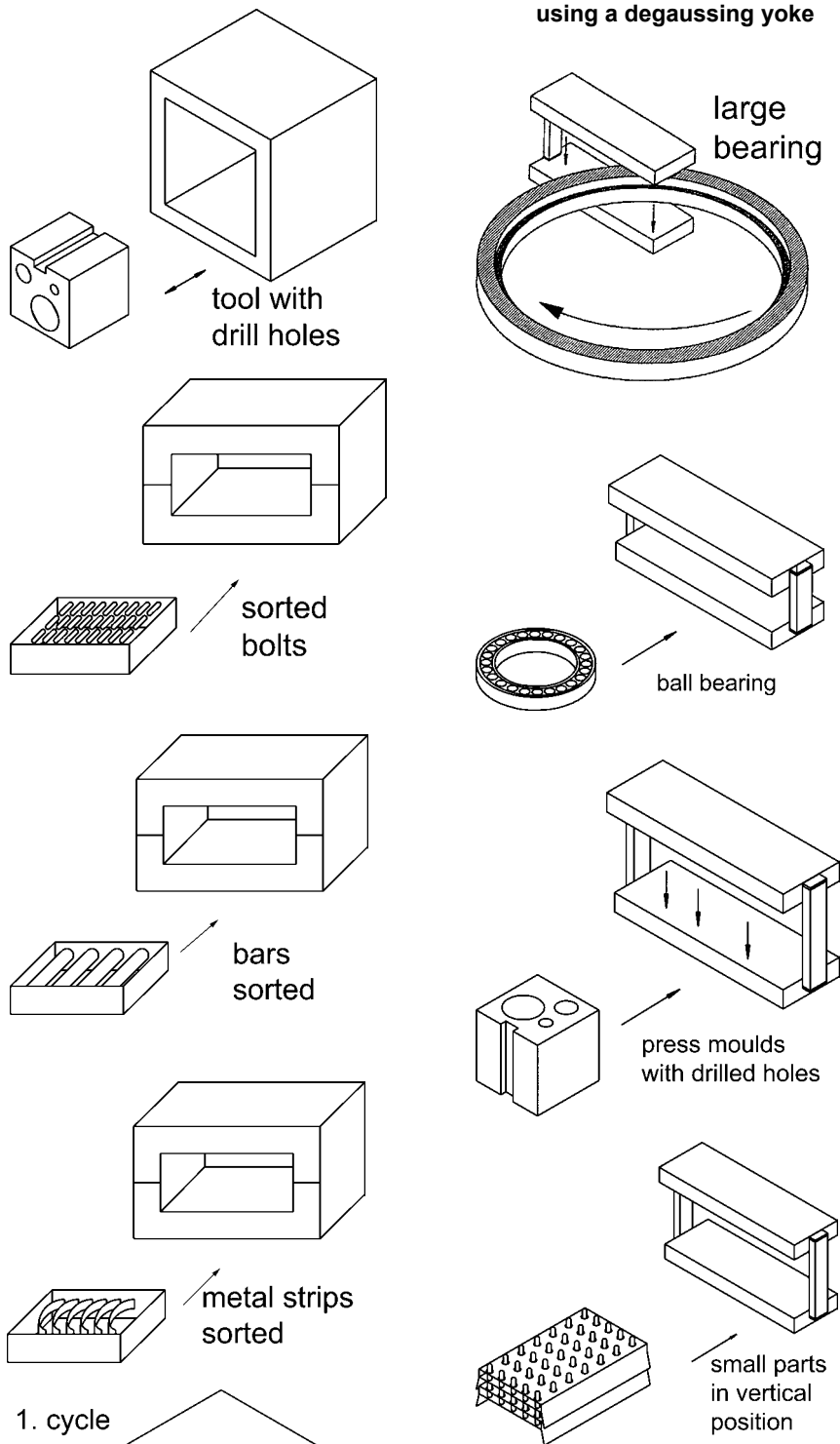

If you have workpieces at various sizes, we recommend degaussing coils with different inside widths in case of substantial variations in size, or the passage of several smaller workpieces through the comparatively large coil opening at a time, thus achieving a favourable bulk factor.

4.2.2 Bulk factor for the degaussing twin yoke

The magnetic field lines are leaving the degaussing twin yoke vertically at its active surface, and - after having passed a determined way - are returning back to the active surface.

The intensity of the magnetic field lines decreases proportionally to the distance covered towards the active surface. Workpieces which are passed through a degaussing twin yoke, should therefore be guided alongside the two yokes as close as possible to the surface.

The distance between upper and lower part of the degaussing twin yoke is therefore adjusted exactly to the size of the workpiece in question. If different sizes are to be processed, the distance between the two yokes should be controlled manually by a crank handle, or by a motor; in any case, the distance between yokes should be adjusted individually to the workpiece.

The maximum distance between yoke surface and workpiece surface should not exceed 10 mm; optimum are 5 - 6 mm (transport belt thickness).

4.2 Bulk factor

4.2.1 Bulk factor for a passage coil

The cross section of the coil opening should be filled to at least 50-60 % with the workpiece. Therefore, we offer a modular coil system which can be adapted exactly to the size of your workpiece. The inside width and inside height of the Vallon degaussing coils can be manufactured at steps of 50 mm.

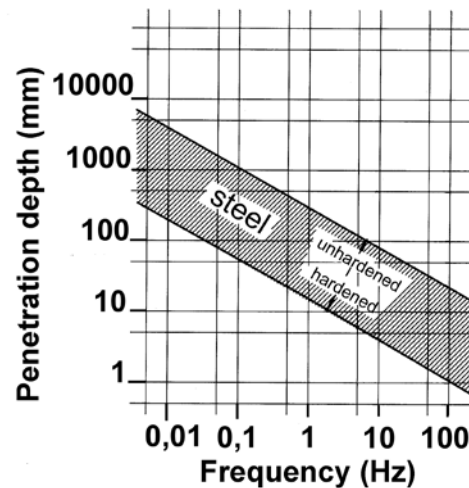

Penetration depth of eddy current

4.3 Frequency of the degaussing field

In order to assure permanent degaussing, it is not enough to only demagnetize the surfaces. The remaining residual magnetic fields in the centre of an object will emerge outwards with the result that, after a few days, the residual magnetism existing before the degaussing procedure will again be measurable.

For reliable degaussing of objects with a wall-thickness > 10 mm, a substantially lower frequency than the standard 50/60 Hz is required. Degaussing at low frequency allows the reduction of the secondary eddy currents inside a workpiece, as well as larger penetration depths into the forced magnetic field. During degaussing of large workpieces (i. e. extruded forms, railroad tracks), frequencies of down to 0.5 Hz are necessary to keep the object magnetically neutral throughout.

For achieving low frequencies, we offer two generator types:

Generator-Type	output frequency
EG 2422	0,9-16,7 Hz, < 60 A
EG 2422S	0,9-16,7 Hz, >100 A
EG 2426	0,5-501 Hz, > 150 A

4.4 Magnetic field intensity

An old rule-of-thumb states:

The harder and tougher a material, the more difficult its degaussing will be.

Standard steel is comparatively easy to degauss with a 50-Hz-coil. Hardened workpieces as well as the particularly tough steels recently introduced by the automotive industry require an extremely strong magnetic field however.

In order to provide extremely high field intensity for permanent operation, the housing material of our degaussing coils is aluminium. The heat conductivity of aluminium is much better than of plastic for example.

4.5 Passage speed

In order to assure reliable degaussing, the poles of the Weiß domains have to be changed several times. This means that the workpiece has to be exposed to the magnetic field of the coil. The correct passage speed is therefore of great importance.

The optimum speed depends on the frequency of the degaussing current. For the Vallon standard coils and yokes, these values are as follows:

Frequency coils	max. speed (approx. values)	
	coils	yokes
50 Hz	250 cm/s	100 cm/s
10 Hz	50 cm/s	20 cm/s
5 Hz	25 cm/s	10 cm/s
2 Hz	10 cm/s	4 cm/s
1 Hz	5 cm/s	2 cm/s

If, for reasons of production technology, higher passage speeds have to be observed, the use of prolonged coils, so-called tunnel coils of up to 800 mm length are necessary.

4.6 Shielding effects

4.6.1 Shielding by transport containers

Workpieces which are demagnetized while stored in transport containers can only with great difficulty be reached by the degaussing field since the field lines will search their way along the outside of the transport container.

Therefore, it is very important that the transport containers are made of materials with low electric and magnetic conductivity. Thus, losses of field lines and the creation of disadvantageous eddy currents will be avoided. Most suitable are non-metal containers as for example made of wood or plastic. If, for technical reasons (washing line) or for reasons of stability, the transport container has to be of metal, we recommend V2A or V4A constructions with a minimum of holes.

4.6.2 Shielding effects by bulk material

Unorientated small parts within a container will substantially diminish the degaussing effect.

Since the magnetic field lines have to cover a certain air gap on their way from pole to pole, the field intensity within the bulk material is extremely low (conductivity of air is 2000 times lower than conductivity of steel).

As a result, the bulk material will be demagnetized only at the surfaces and within the peripheral zone, while the centre remains uninfluenced in terms of magnetism.

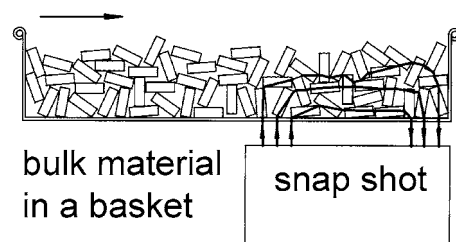

Degaussing of bulk materials should therefore only be performed if there is no other option. We recommend to fill the transport container 2 cm high, and degauss from below with a degaussing yoke.

5. Measuring a magnetic field

The Vallon field strength meter VFM1 allows the measurement of residual magnetism of workpieces before and after degaussing. This gauge is equipped with 2 automatically changing measuring ranges $\pm 19,99$ Gauss and $\pm 199,9$ Gauss (1 G corresponds to 1 A/cm). The measuring precision is $\pm 2\%$ and the max. resolution is 0,01 G.

Handling is quite simple. Just approach the lower side of the meter to the object to be measured.



6. Data for project planning of a degaussing installation

The selection of the adequate degaussing installation requires a thorough experimental knowledge, and depends greatly on the workpieces and their handling.

Therefore, Vallon offers versatile and customized solutions allowing not only best degaussing results but also perfect integration into a production process.

Already when making out an offer, we are considering the below facts:

- * implementation of a degaussing coil or a degaussing yoke
- * degaussing at low frequency or at standard frequency, 50/60 Hz, which is more economic
- * manual degaussing or with automotive system

7. Product range and contacts

Sometimes, we have not enough information from interested clients - we then discuss your application in detail on the phone or at customer's site.

If the degaussing system is to be integrated into a production line, or if the workpiece handling is to be provided by us, project assessment at your site will be performed.

We offer solutions ranging from manually operated small systems to automatic large-scale installations.

Particularly complex or difficult tasks will be checked in our applications laboratory; here, we find out the best way of degaussing your specific products, considering your requirements.

Please contact us:

Phone: +49-7121-9855-0

Fax: +49-7121-83643

E-mail: info@vallon.de

Web.: www.vallon-degaussing.com

8. Conversion table for magnetic field strength and induction

→ ↓	Oe	A/cm	kA/m	g	G*	T*	nT*	Vs/m ²
Oe	1	0,796	0,0796	10 ⁵	1	10 ⁻⁴	10 ⁵	10 ⁻⁴
A/cm	1,256	1	0,10	1,256x10 ⁻⁵	1,256	1,256x10 ⁻⁴	1,256x10 ⁵	1,256x10 ⁻⁴
kA/m	12,56	10	1	1,256x10 ⁶	12,56	1,256x10 ⁻³	1,256x10 ⁶	1,256x10 ⁻³
g	10 ⁻⁵	0,796 ⁻⁵	0,796 ⁻⁶	1	10 ⁻⁵	10 ⁻⁹	1	10 ⁻⁹
G*	1	0,796	0,0796	10 ⁵	1	10 ⁻⁴	10 ⁵	10 ⁻⁴
T*	10 ⁴	7,96x10 ³	7,96x10 ²	10 ⁹	10 ⁴	1	10 ⁹	1
nT*	10 ⁻⁵	0,796x10 ⁻⁵	0,796x10 ⁻⁶	1	10 ⁻⁵	10 ⁻⁹	1	10 ⁻⁹
Vs/m ²	10 ⁴	7,96x10 ³	7,96x10 ²	10 ⁹	10 ⁴	1	10 ⁹	1

*Those are the units for magnetic induction. Since, in practice, those values are measured only at surface and not in the centre, comparison with units indicating magnetic field strength is not possible.

Example for conversion:

Given: 25 G

Wanted: nT

From table: 1 G = 10⁵ nT or 1 nT = 10⁻⁵ G

Solution: 25 G x 10⁵ nT/G = 25 x 10⁵ nT = 2,5 x 10⁶ nT = 2.500.000 nT

9. Customer experiences working with Vallon lines

Large pipes, seamless

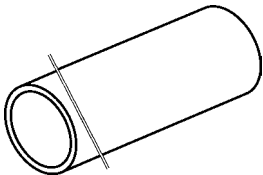

Material: St37, St 52, X60, X70
 Diameter: 800 mm
 Wall-thickness: 20 mm
 Speed: 12 m/min
 Residual magnetism: < 5 A/cm

Large pipes, longitudinal welding

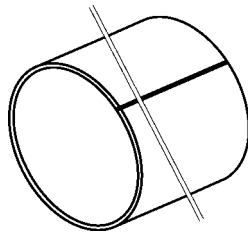

Material: divers
 Diameter: 1300 mm
 Wall-thickness: 25 mm
 Speed: 12 m/min
 Degaussing: before welding
 Residual magnetism :< 5 A/cm between welding walls

Large pipes, longitudinal welding

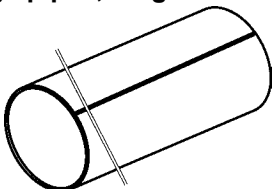

Material: divers
 Diameter: 530 mm
 Wall-thickness: 8 mm
 Length: 11 m
 Speed: 12 m/min
 Degaussing: before welding
 Residual magnetism:< 2 A/cm between welding walls

Pipes, seamless

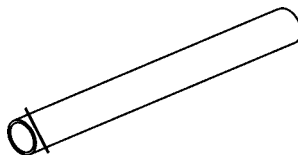

Material: steels (ball bearings)
 Diameter: 17-120 mm
 Wall-thickness: 1-20 mm
 Speed: max. 96 m/min
 Residual magnetism: < 5 A/cm

Bundle of pipes

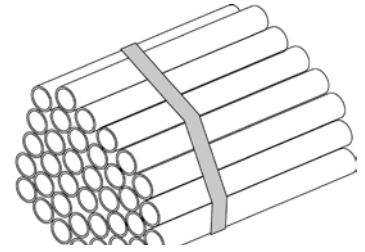

Material: St30, St35, St37, St55
 Diameter: 15-111 mm
 Wall-thickness: 2-11 mm
 Length: 12 m
 Number of pipes: 11-150 pieces
 Weight: approx. 3 t
 Speed: 6-12 m/min
 Residual magnetism: < 5 A/cm.
 The residual magnetism is to be measured at the single pipes, after disbanding the bundle, since for the bundle the earth gravity will simulate a higher residual magnetism.

Steel plates

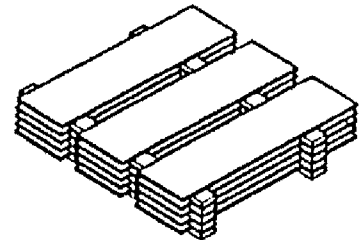

Dimensions: 300 x 15 x 2400 mm³
 Number of pieces: 15 ea. on tray
 Speed: 5m/min
 Residual magnetism:< 5 A/cm

Tubular springs

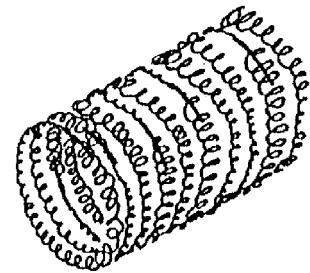

Diameter: 50-250 mm
 Residual magnetism: < 2,5 A/cm

Piston rings

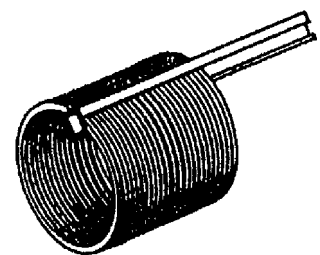

Diameter: 140-190 mm
 Residual magnetism: < 3 A/cm

Ball-bearing rings

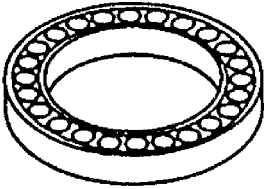

Diameter: 20-300 mm
 In passage: with ES2421-system
 Manually: with EMJ-2B
 Residual magnetism: < 0-1,5 A/cm

Cylindrical tools

Diameter: 200-1300 mm
 Height: 10-800 mm
 Weight: 15-1200 kg
 Residual magnetism: < 1-5 A/cm

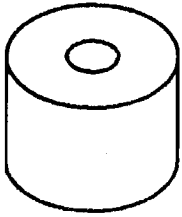

10. Degaussing coils in modular Vallon system

The coils of the EM series are all equipped with an aluminium body, designed for permanent operation. If particularly high field intensity is required, air-cooled versions are available. We build special coils of up to 1700 mm diameter.

The modular system works as follows:

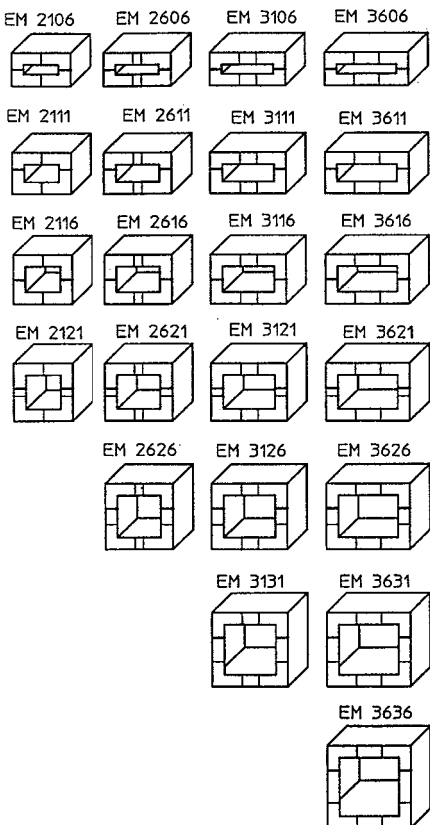

EM2116 = inside width 210 x 160 mm², depth always 270 mm. For special dimensions and tunnel coils with special lengths:
 Inside width + 150 mm, length + 150 mm.



EM2116, inside width: 210 x 160 mm
 Dimensions: 360 x 310 x 270 mm
 Voltage: 230 V/50 Hz/0.5 kVA
 Protection: IP 44,
 weight approx. 35 kg



EM06, inside width 60 mm Ø
 Dimensions: 245 x 245 x 120 mm
 Voltage: 230 V/50 Hz/0.5 kVA
 Protection: IP 44, weight approx. 12 kg



EM06-650, inside width 60 mm Ø,
 with additional air-cooling (+250 mm)
 Dimensions: 245 x 245 x 650 mm
 Voltage: 400 V/1-10 Hz/6 kVA
 Protection: IP 44, weight approx. 100 kg



EM06S-650, inside width 60 mm Ø,
 Dimensions: 245 x 245 x 650 mm
 Voltage: 400 V/50 Hz/2,8 kVA
 Protection: IP 44, weight approx. 60 kg

EM1616R, coil with rotating field
 inside width: 163 x 163 mm
 Dimensions: 440 x 380 x 210 mm
 Voltage: EG2422 400 V/1- 10 Hz
 Performance: 12 kVA max.



11. Degaussing yokes



EMJ05, active width 50 mm,
 Dimensions: 160 x 110 x 70 mm
 Voltage: 230 V/50 Hz/80 VA
 Protection: IP 65. weight approx. 4.3 ka



EMJ80B, active width 800 mm,
 Dimensions: 910 x 280 x 126 mm
 Voltage: EG2422 400V/1-10 Hz/9 kVA
 Protection: IP 55, weight approx. 132 kg



EMJ80-2B, active width 2 x 800 mm,
 Dimensions: each 910 x 280 x 126 mm
 Voltage: EG2422 400V/1-10 Hz/ 16 kVA
 Protection: IP 55,
 weight: approx. 2 x 132 kg



EG2422, low-frequency generator
 19"-Rack
 Inside housing: 560 x 415 x 190 mm
 Voltage: 400V/50 Hz/60 A
 Output: 400 V, 0,9-16,7 Hz 24 kVA
 Protection: IP 55, weight approx. 22 kg

12. Complete Degaussing lines

Examples
EJT30



Transport conveyor, width 300 mm
Twin yoke EMJ30-2B
LF-Generator EG2422, Control
bulk material, 2 cm inside plastic
container
EJT40



Degaussing table with holding device,
single yoke EMJ40 50 Hz in carrier,
bulk material, 2 cm inside plastic
containers

EMR16 for piston rings



centring and transport system
EM1616R coil with rotating field
LF-Generator EG2422 Control

EMR80

Transport system for
manual operation with
2 stations: on the left
for steel rings of up to
1800 mm Ø and
500 kg, the rings rotate
in place - on the right
for extruder blocks
of up to 400 x 400 x
800 mm and 1000 kg
- blocks are pushed
through the roller
conveyor from front to
rear.

Twin yoke EMJ80-2B
adjustable in height
and movable from
station 1 to station 2.
LF-Generator EG2421



EJT50-2B

Transport conveyor,
width 500 mm for
roller bearings
 housings of up to
500 mm Ø.

Twin yoke EMJ50-
2B motor height
adjustment and
LF-Generator
EG2422.



EMS3636

Degaussing of thick-
walled pipes. High-
performance coil
EM3636A with cooling
system, mounted
on mobile slide, LF-
Generator EG2422S.



Low Frequency Generator EG2426

automatic adaptation of the
degaussing frequency to the size
of the workpiece
symmetrics and maximum voltage
can be selected
suitable for connection to all
Vallon degaussing coils of the A series

